



HTM300M-72

Electrical Characteristics

HTM285W-290W-295W -300W(156M)



Mechanical Characteristics

Dimensions (mm)	1957 × 992 × 40
Weight (kg)	22.5kg
Solar cells	72 cells (156mm 6 × 12)

Performance

High Transmission, Low Iron Tempered Glass bypass diodes protection

Warranty	90% power output over 12 years
	80% power output over 25 years
	Free from defects in materials and workmanship for 10 years

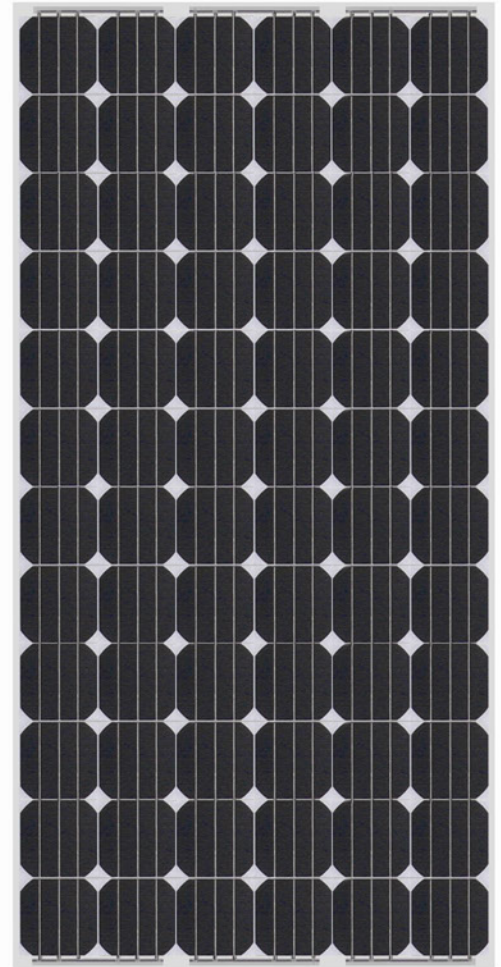

HTM300M-72(156MONO)

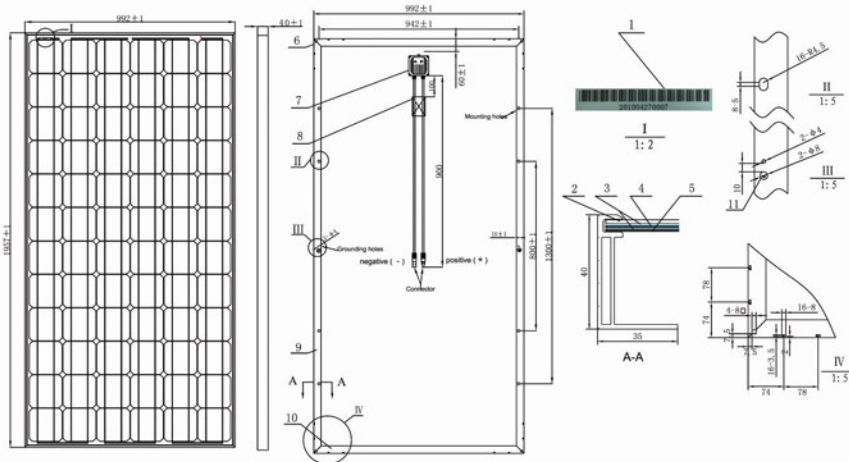



Parameter

Rated Maximum Power(Pm)	285W	290W	295W	300W
Voltage at Pmax (Vmp)	36.2V	36.2V	36.7V	36.7V
Current at Pmax (Imp)	7.87A	8.01A	8.04A	8.17A
Open Circuit Voltage (Voc)	44.9V	44.9V	45.5V	45.5V
Short Circuit Current (Isc)	8.50A	8.65A	8.68A	8.83A
Module Efficiency	14.68%	14.94%	15.19%	15.45%
Power tolerance (% Pmax)	0/+3%	0/+3%	0/+3%	0/+3%
Maximum Series Fuse Rating				15A
Maximum System Voltage				1000VDC
Operating Temperature				-40°C to +85°C
Temperature coefficients of Pm				-0.43%/°C
Temperature coefficients of Voc				-0.30%/°C
Nominal Operating Cell Temperature				47±2°C
Standard Test conditions	STC: 1000W/m ² AM: 1.5 Module Temperature: 25°C			